

UNIVERSAL FLUSH MANIFOLD

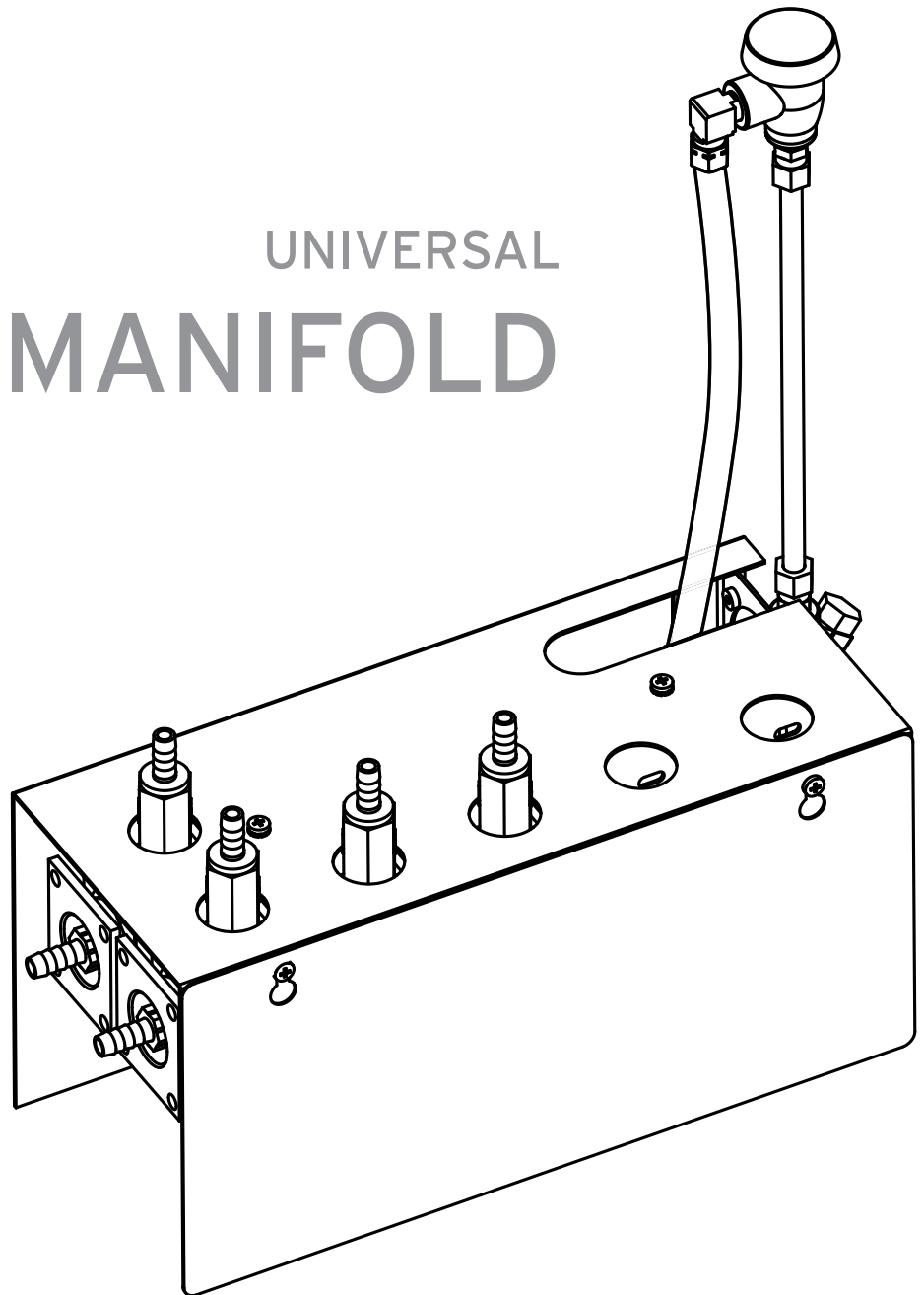

Installation & Operation Manual

Retain this manual for installation, operation, and servicing information.

TABLE OF CONTENTS

1.0 System Introduction	
1.1 Preface	1.1
1.2 System Features	1.1
1.3 Principle of Operation	1.1
1.4 Universal Flush Manifold Description	1.2
2.0 Specifications	
2.1 Universal Flush Manifold	2
2.2 Installation Space Requirements	2
2.3 Utilities	2
3.0 Installation Procedures	
3.1 Preplanning the Installation	3
3.2 Flush Manifold Installation	3
3.3 Pump Tube Installation	3
3.4 Flush Tubing Installation	3
3.5 Electrical Connection - Tri-Star XP Pump Module	3
3.6 Electrical Connection - AeroLite XP Pump Module	3
4.0 Set-up and Operation	
4.1 Product/Wash Signal Check	5
5.0 Troubleshooting	
5.1 Pumps will not run, flush manifold is alarming	5
5.2 Pumps will not run, flush manifold is not alarming	5-1
5.3 Flush System Logic - Tri-Star XP	5-1
5.4 Flush System Logic - AeroLite XP Pump Module	5-1
6.0 Replacement Parts	
6.1 Universal Flush Manifold Assembly	6-1
6.2 Universal RPZ and Tempering Valve Kit	6-2
7.0 Backflow Prevention	
7.1 Installation Recommendations	7-1

1.0 SYSTEM INTRODUCTION

1.1 Preface

This manual has been written and illustrated to present the basic installation, operation, and servicing instructions for the Tri-Star XP and AeroLite XP pump module Flush Manifold.

Guidelines will be suggested in reference to the preferred method of installation. However, the variety of equipment and the surrounding environment will dictate the actual installation of the Flush Manifold.

WARNING



These installation and servicing instructions are for use by qualified personnel only. The installation must be made in accordance with local plumbing and electrical codes.

1.2 System Features

When used with the Tri-Star XP and AeroLite XP pump module dispensing systems, the Flush Manifold completes an integrated water flush chemical dispensing system. All products inject into the manifold via check valves. The Tri-Star XP and AeroLite XP pump module controls water flow to transfer product through a pair of tubes to the laundry machine.

- A fully integrated system with flow monitoring.
- Alarm system activates and pumps shut down if low water flow is detected when flushing.
- One plug electrical connection to the Tri-Star XP and AeroLite XP pump module for easy installation.

1.3 Principle of Operation

The Universal flush manifold operates in conjunction with the Tri-Star XP and the AeroLite XP pump module. The Universal flush manifold provides an optional means of chemical transfer to the laundry machine. The Universal flush manifold accepts products through check valves. Two seconds prior to the operation of any pump the flush solenoid valve will open. The low flow safety switch must be closed prior to the operation of any pump. The peristaltic pump delivers product to the manifold, which dilutes and transfers product to the laundry machine. An independent check valve and injection module has been provided for acid or sour. A flow sensor monitors water flow when the solenoid valve is open. If the flow rate falls below .6 GPM all peristaltic pumps will stop running and, after a two second delay, trigger a system alarm. Two injection lines will be routed to the washer.

Tri-Star XP operation includes a programmable post flush time set at the Control Module Keypad. When multiple pumps run simultaneously, post flush time begins when the last pump stops.

1.4 Universal Flush Manifold Description

NOTE 	Paragraph numbers below refer to labeled items in Figure 1-1.
--	---

1. Water Supply Barb Fitting: A 1/2" ID Hose Barb connector for water supply tubing from the RPZ to the solenoid valve.
2. A 24 VAC water solenoid valve.
3. Flow Sensor: Provides closed contacts to the pump cabinet when flow is present.
4. Activates an audible alarm if low flow is sensed while dispensing and flushing.
5. Interface Cable: One plug connection to the Pump Cabinet for solenoid, flow switch, and alarm wiring.
6. 3/8" OD Hose: Connects the Solenoid Module and Flow Sensor to the Manifold Assembly.
7. Check Valves: One way check valves allow product injection into manifold and prevent water flow back to pumps. Use short lengths of 3/8" ID flexible tubing and clamps to connect to the peristaltic pumps.
8. 2 Flush Discharge Barb Fittings: A plastic 3/8" ID Hose Barb fitting for plastic tubing.
9. Manifold Assembly: Consists of the manifold segment, o-rings, product injection check valves, and tube fitting.
10. Detergent Check Valve: For use with L-2000 and other detergents.

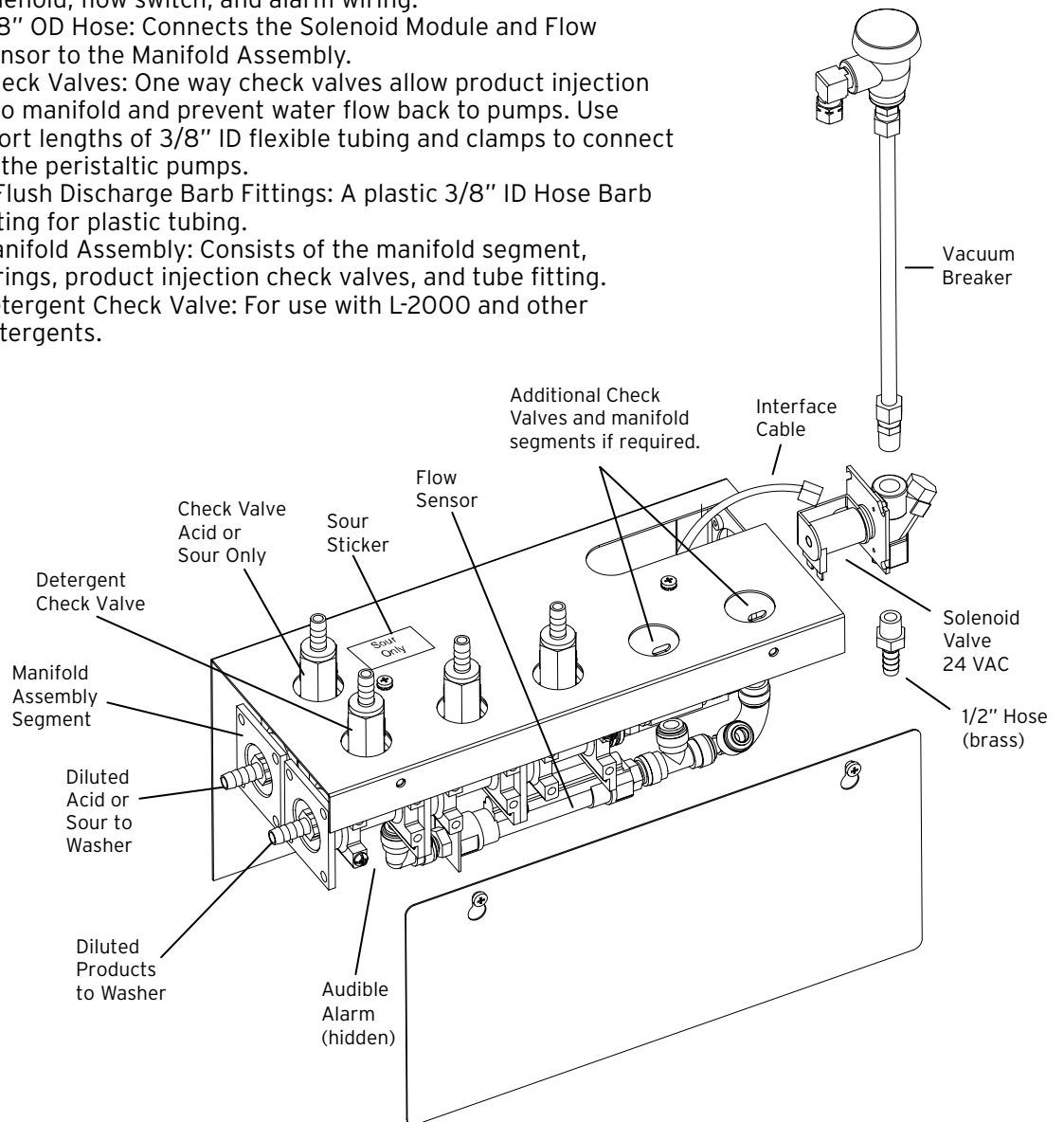

2.0 SPECIFICATIONS

2.1 Universal Flush Manifold

2.1.1 Dimensions

- Height (H): 19" (43.3 cm)
- Width (W): 14.5" (36.8 cm)
- Depth (D): 6.25" (15.9 cm)
- Weight: 5 lbs (2.27 kg)

2.1.2 Service Access

The front cover is removable, held in place by two machine screws located on the front of the enclosure. The interface cable exits through the side of the enclosure. Use silaprene sealant on all plastic pipe threads.

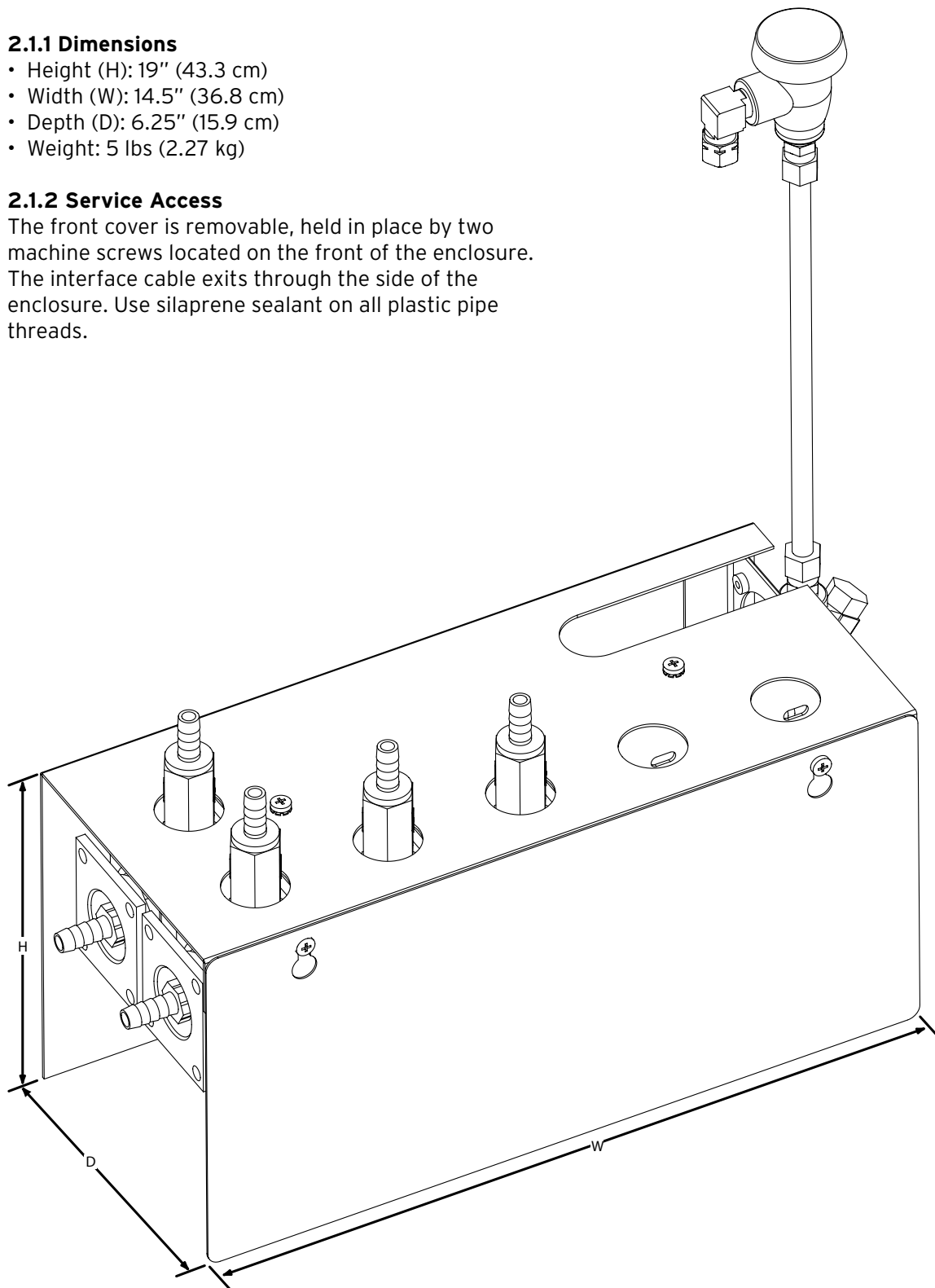

2.2 Installation Space Requirements

2.2.1 Dimensions

- Height (H): 26" (66 cm)
- Width (W): 20" (50.8 cm)
- Depth (D): 8" (20.3 cm)

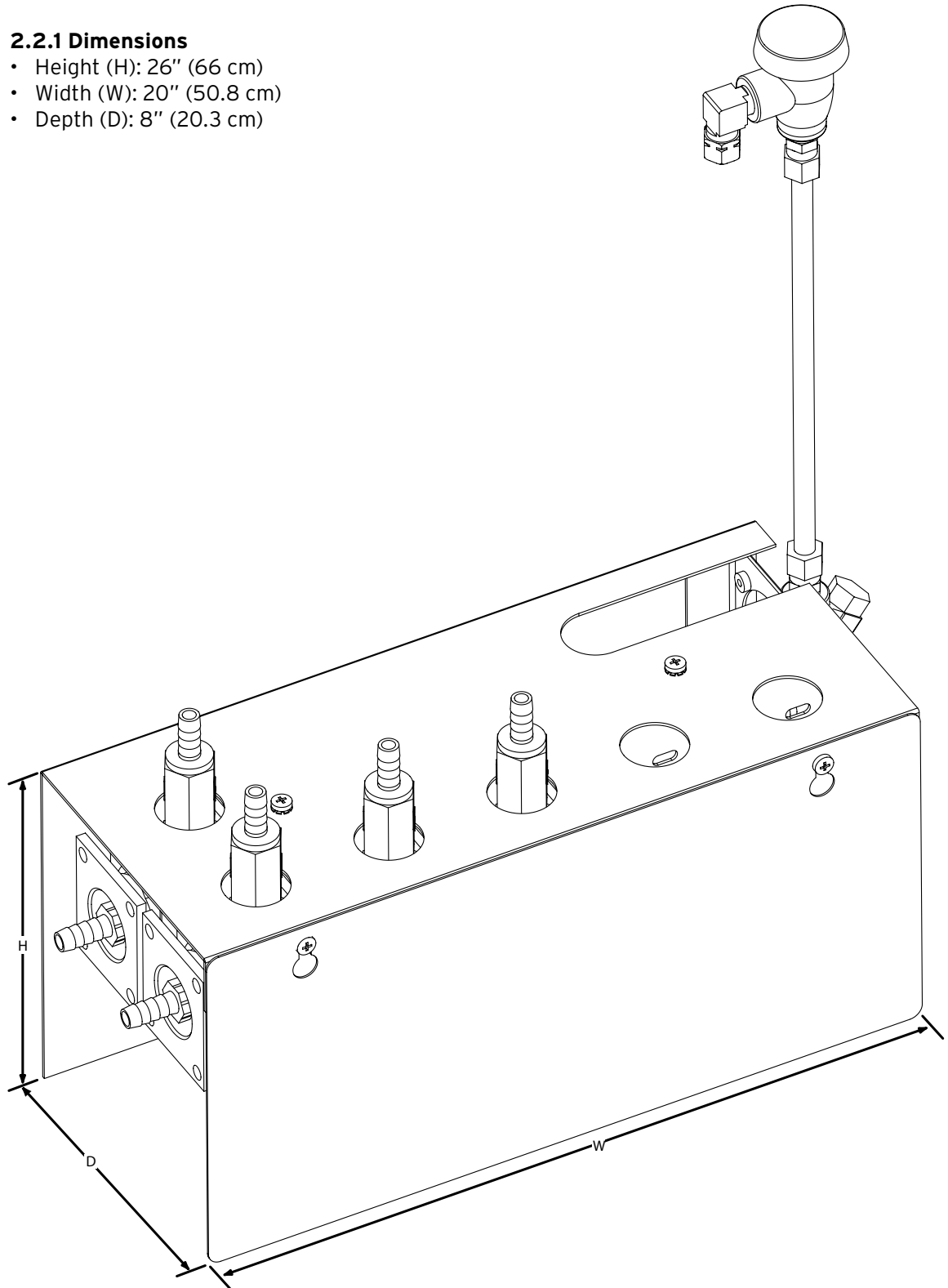

2.3 Utilities

2.3.1 Electrical Supply

- Low voltage (24 VAC) power is supplied by the Tri-Star XP and AeroLite Pump Module.
- The unit is shipped with a 51" fixed length Interface Cable.

2.3.2 Water Supply

NOTE 	The Flush Manifold System must be used in conjunction with an approved backflow device. See section 7.0 for additional information.
--	---

- 1/2" ID nylabraid tubing water supply is required for Water/Flush supply connection from the RPZ, if used.
- Maximum water temperature must not exceed 120° F (49° C). A tempering valve must be installed. See section 7.0.
- Minimum water flow rate is .6 GPM. Check with 5 gal. bucket when all washers are filling.

NOTE 	Two (2) Manifolds may share the same water supply by using a TEE at the 1/2" RPZ.
--	---

NOTE 	3-5 Manifolds may share the same water supply by using a TEE at the 3/4" RPZ.
--	---

3.0 INSTALLATION PROCEDURES

3.1 Preplanning the Installation

There is no substitute for planning the installation prior to beginning the work. Several minutes in planning may save an hour or more during the installation. The following is a list of factors to consider before the installation of the system begins.

NOTE 	This Flush Manifold WILL NOT function on some of the original Tri-Star XP units. The Universal flush manifold works with the AeroLite XP pump module.
--	---

- Locate the Pump Cabinet within 50 ft of Laundry Machine.
- Locate the Manifold Assembly directly underneath and within 2 ft. of the Pump Cabinet.

NOTE 	Allow clearance for plumbing connections on left side of cabinet. Allow for clearance for the vacuum breaker on the right side.
--	---

- The Flush Manifold assemblies must be securely anchored to the wall.
- Outlet tubing must not exceed 50 ft in length.
- Water flow of 20 psi.
- Recommended operating temperature range is 90F (32.2C) to 120F (48.9C)
- Use a maximum of two Flush Manifold assemblies to (1) 1/2" RPZ valve.
- Three to 5 Flush Manifold assemblies to (1) 3/4" RPZ valve.

NOTE 	Order and mount additional Manifold Assembly segments in the Flush Manifold Cabinet if more than 4 products will be using the Flush Manifold (Max. 6).
--	--

3.1.1 Materials Ordered Separately

- 3/8" ID polyflow tubing for pump squeeze tube to check valve connections.
- 3/8" ID polyflow tubing for water discharge lines to laundry machine.

3.2 Flush Manifold Installation

Review the pre-planning information before installing the Universal Flush Manifold.

1. Position the Manifold Assembly on the wall below the Pump Cabinet.

NOTE 	Allow clearance for the Tri-Star XP Pump Module cabinet to swing open.
--	--

2. Using a pencil, outline each of the two holes in the Manifold.
3. Drill the outlined holes with a 1/4" masonry bit and place a wall anchor, supplied in the installation kit, into each hole.
4. Secure the Manifold Assembly to the wall anchors with supplied screws.

3.3 Pump Tube Installation

1. Connect short lengths of 3/8" ID polyflow tubing to the peristaltic pump tube outlet barb fittings. Secure with hose clamps to ensure a leak free assembly.
2. Trim the 3/8" ID polyflow tubes to fit—do not connect to the check valves yet.
3. Perform "Calibrate Pumps", capture product at the ends of the of tubing.
4. Connect to the barb fittings on the Flush Manifold check valves. Secure with hose clamps to ensure a leak free assembly.

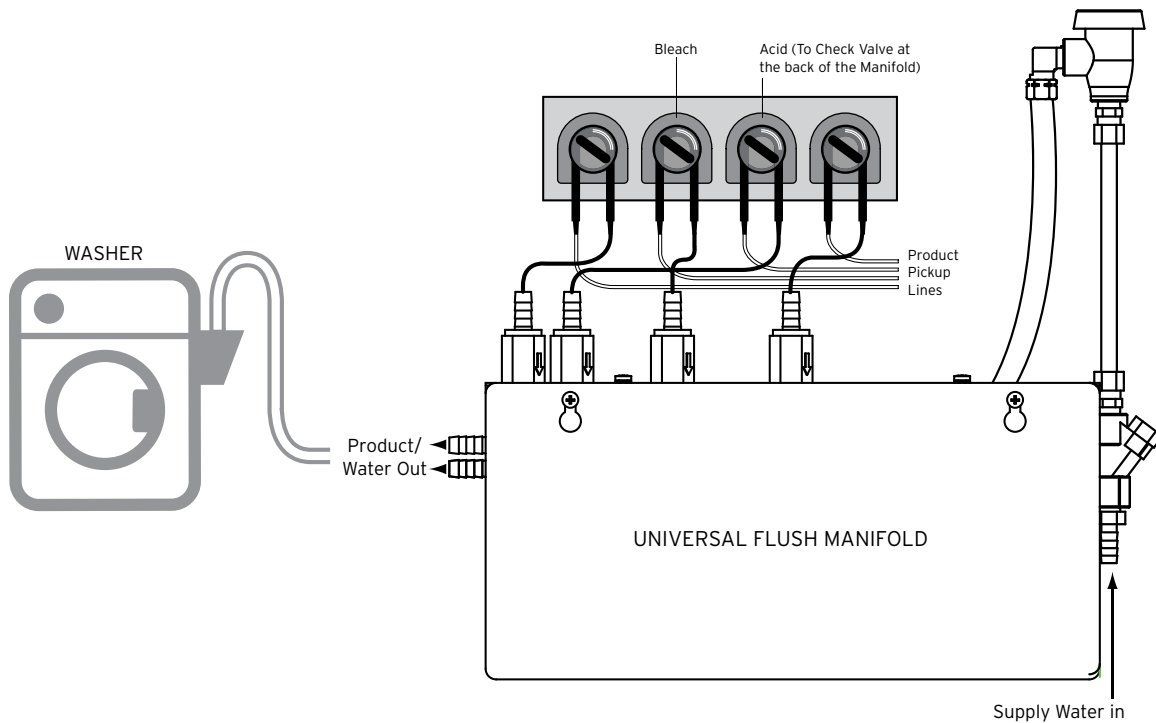

3.4 Flush Tubing Installation

If an RPZ is installed connect 1/2" ID nylabraid tubing for water supply connections from the Tempering Valve/RPZ Back Flow Preventer to the Flush Manifold solenoid valve barbed fitting.

Use a pair of 3/8" ID Polyflow flush outlet tubes to deliver all products to the laundry machine. It is important that the flush discharge tubing DOES NOT exceed 50'.

3.4.1 Water Supply Connection

1. Install 1/2" ID nylabraid tubing from the RPZ—not provided—to the Flush Manifold water supply connection (Bottom hose barb fitting connector).
2. Connect the hose to the output of the RPZ.

3.4.2 Flush Discharge Connection

1. Install 3/8" ID Polyflow from the Flush Manifold outlets to the laundry machine.
2. Clamp the tubing to the Flush Manifold discharge fitting.
3. Route the tubing to the laundry machine and secure at the product injection port.

NOTE

Secure the flush discharge tube at the laundry machine so that the water flush will rinse the product injection area. This will help ensure against chemical attack to the laundry machine. Be sure discharge is aimed and secured to avoid splashing outside of injection area. Secure all tubing for a neat and clean installation.

3.4.3 Hard Copper Plumbing

If the water supply connection must be copper tubing, you will be responsible for the correct pipe fittings and connectors to complete the installation. Hard plumbing may require a licensed plumber. Follow all state and local plumbing codes. See Section 7.0 for details on water supply connections. Plastic compression fittings can be removed and replaced with the appropriate fittings to accommodate copper tubing. Use silaprene on the plastic plumbing threads and DO NOT solder to fittings that are threaded into plastic. Water supply lines require a minimum 1/2" tube.

3.5 Electrical Connection - Tri-Star XP and Aerolite XP Pump Module

1. Locate and remove the 6 pin white connector on the bottom of the pump cabinet—this connector will have one yellow wire looped from pin 3 to pin 6. Depress the locking tab on the back side of the connector to release it.

NOTE

Save the connector removed in step 2 for future use. Pumps will not run without either this shorting connector or the Interface Cable connected at J4.

2. Plug the manifold interface cable into the bottom of the pump cabinet—the connector was removed from in step 2.
3. Install the supplied cable strain relief—with loop facing the wall—by pinching with pliers and pushing upwards through the hole.

4.0 SET-UP AND OPERATION

The following procedures are designed to check out the system to ensure that everything is operating correctly. It is assumed that these steps have been completed:

1. The Pump Cabinet system is installed, programmed, calibrated, and checked out.
2. The Flush Manifold is properly plumbed.
3. Water supply conditions are correct for the Flush Manifold and the water supply is on.
4. The Control Module Cable is connected to the Pump Cabinet.

4.1 Product/Wash Signal Check

1. Program the Tri-Star XP Controller "Post-Flush Time" for the length of time necessary to flush product to the laundry machine. The Aerolite XP is set for 30 seconds minimum and cannot be lowered under 30 seconds.
2. Select a formula and run the laundry machine through a complete cycle.
3. Flushing should begin two seconds prior to any pump and remain until "Flush Time" ends.

NOTE 	"Flush Time" begins after the pump(s) stops running.
---	--

NOTE 	If any problems are found consult section 5.0, Troubleshooting.
--	---

4. Check for water leaks at all plumbing connections.

5.0 TROUBLESHOOTING

5.1 Pumps will not run, flush manifold is alarming	
Possible Cause	Resolution
No Power [24 VAC] to the manifold solenoid valve	Check for loose wires. Replace the pump cabinet PC board
Manifold solenoid valve is not opening, or partially opening	Replace the valve coil and/or the valve body
Manifold or discharge tubing is plugged, no water flowing through the manifold	Check for obstruction in valve body, and the solution discharge tubing to the laundry machine
Good flow of water through the manifold, but it is still alarming and pumps won't run	Faulty manifold flow sensor. Bypass sensor to confirm. Then replace sensor

5.2 Pumps will not run, flush manifold is not alarming	
Possible Cause	Resolution
No supply signal[s] from laundry machine	Confirm signal voltage at the laundry machine signal strip.
Faulty dispenser signal interface	If signal voltage is present, replace the dispenser interface
Faulty dispenser control module or communication cable.	If interface is responding to signals, replace module or cable.
Faulty pump cabinet printed circuit board.	If all of the above has been changed, replace circuit board.

5.3 Flush System Logic - Tri-Star XP

- The Tri-Star XP/Aerolite XP and the Flush Manifold offer the security of a fail-safe interlock system.
- The Tri-Star XP/Aerolite XP Pump Module pumps will not run unless either the shorting plug or the Flush Manifold Interface Cable is connected.
- Should there be a low water pressure problem, the Flow Sensor will detect a no flow condition. When the water flow rate drops below .6 gpm, pumps are stopped, and, after a 2 second delay, the system alarm will activate. Normal operation resumes automatically when the failure is corrected.

5.4 Flush System Logic - AeroLite XP Pump Module

- The AeroLite XP Pump Module and the Flush Manifold offer the security of a fail-safe interlock system.
- The AeroLite XP Pump Module pumps will not run unless either the shorting plug or the Flush Manifold Interface Cable is connected.
- The AeroLite XP Pump Module post flush time is fixed at 30 seconds.
- Should there be a low water pressure problem, the Flow Sensor will detect a no flow condition. When the water flow rate drops below .6 gpm, pumps are stopped, and, after a 2 second delay, the system alarm will activate. Normal operation resumes automatically when the failure is corrected.

7.0 BACKFLOW PREVENTION AND INSTALLATION RECOMMENDATIONS

Providing the Required Backflow Prevention and Water Specifications to the Universal Flush Manifold.



Plumbing Codes Require Proper Backflow

Chemical dispensing systems that use a potable water supply to provide “chemistry” to a cleaning system are required by plumbing codes to provide proper backflow prevention. This prevents the product chemistry from back-flowing and contaminating the potable water supply in the case of a plumbing failure. We have always required all Universal Flush Manifolds to be installed in accordance with the local code. Our method typically has been to use an RPZ (reduced pressure zone) which provided the required backflow prevention. Flush manifolds installed without backflow prevention are in violation of plumbing backflow codes. Be advised that local plumbing codes may require a certified plumber to install the RPZ.

Modifications to the Universal Flush Manifold now Feature Backflow Prevention for Most Applications

Design modifications to the Universal Flush Manifold now include an approved atmospheric vacuum breaker (see photo at left). The AVB will now be shipped with each manifold (assembly required). This modification will meet most local and State plumbing codes. However, some installations will still require an RPZ to be installed. Refer to the information on the following pages for clarification. All flush manifold installations must include an approved backflow prevention device.

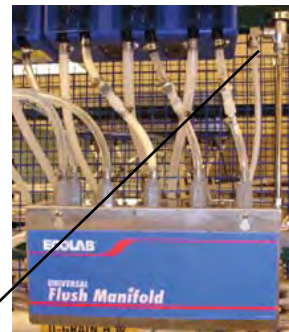

Vacuum Breaker

Modifications to the Universal Flush Manifold now Feature Backflow Prevention for Most Applications

Maintaining the recommended water temperature and pressure applied to the Universal Flush Manifold is very important.

- Water temperature: The recommended temperature range for water applied to the manifold is 90 - 120F. Do not use cold water only. Some product chemistry, especially fabric softeners, has a tendency to “gell” in cold water conditions. This can lead to residual chemical stains if the product stays in a gelled form on the fabric. Do not use hot water only. Hot water can compromise the seals and o-rings resulting in segment or check valve leaks and/or failures.
- Water pressure: Water flow pressure to the flush manifold must be set at 20 - 30 PSI. Water supplied to most accounts from a municipal source will have static PSI in the range of 40 - 60. The squeeze tubes in our peristaltic pumps cannot pump product into the manifold (through the grey plastic check valve) under such pressure. The raw product will accumulate (under pressure) between the squeeze tube and check valve. Once the manifold water solenoid valve shuts off and the pressure stabilizes, the check valve opens and the concentrated product shoots into the manifold in a raw form and stays there until the next product feed. This can result in chemical stains and/or burns.
- Using a regulating and tempering valve device: Regulating water feed temperature and PSI is accomplished by the use of an approved device, either in the form of the Flush Manifold tempering valve kit 9252-4396 (pictured above) or the “ ” RPZ tempering kit 9200-1502 (pictured at right) Both devices include a tempering valve and water pressure regulators.

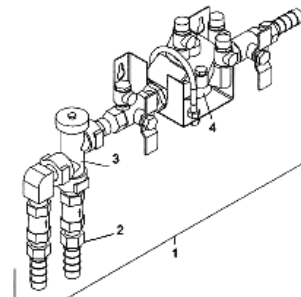

Proper Flush Manifold Installation...An RPZ vs. the Tempering Valve Kit

Plumbing codes prescribe proper installation when vacuum breakers are used on chemical dispensing systems. Product discharge tubing on such dispensers cannot be run above a point 6" below the dispenser vacuum breaker (see photo below). With most laundries (like the installation below) this will not be an issue. However if your discharge tubing requires a run that goes up into a ceiling (or over a wall), and then down into the laundry machine, the flush manifold will have to be installed in conjunction with an RPZ device (see information on the following page).

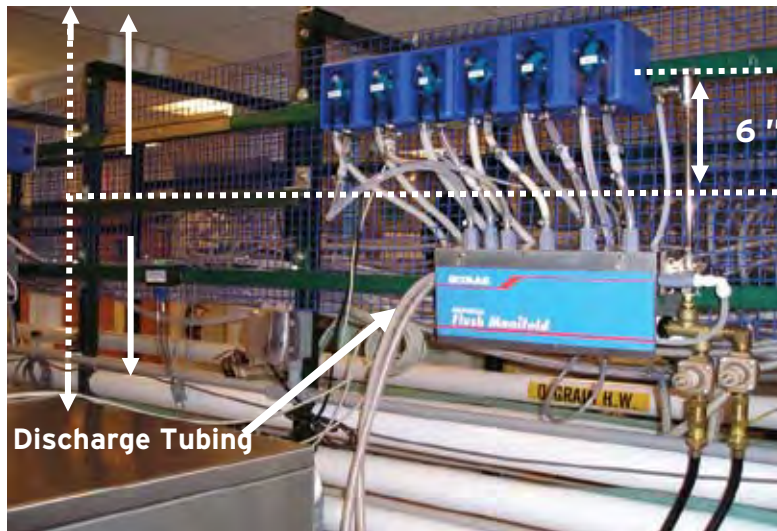

Backflow Options

Option 1:

If the laundry requires the installation of **one or two manifolds**, order one Universal Flush Manifold (9259-1262) per each dispenser pump cabinet. Also order one Flush Manifold Tempering Valve Kit per each manifold ordered. **This option is to apply only to flush manifolds where the discharge tubing from the manifold to the laundry machine is run at a point no higher than the 6" restriction** (see the diagram on page 2).

Option 2:

If the laundry requires the installation of **three to five flush manifolds**, order one Universal Flush Manifold (9259-1262) per each dispenser pump cabinet. Also order one **" RPZ kit (9200-1502)**. This RPZ kit will provide backflow prevention for the 3 - 5 flush manifolds. Do not order one RPZ for each manifold installed. This type of installation also requires additional parts... contact Technical Service

Option 2:

If the laundry installation requires the **product discharge tubing from the flush manifold be placed up into a ceiling (or over a wall), and then down into the laundry machine**, an RPZ must be installed. This applies to any number of flush manifolds installed.

Replacement Manifolds:

Universal Flush Manifolds shipped from Beloit will now include the approved vacuum breaker. When replacing existing flush manifolds that do not include an approved backflow device, the installation **must** be modified as outlined above to bring the account into compliance.

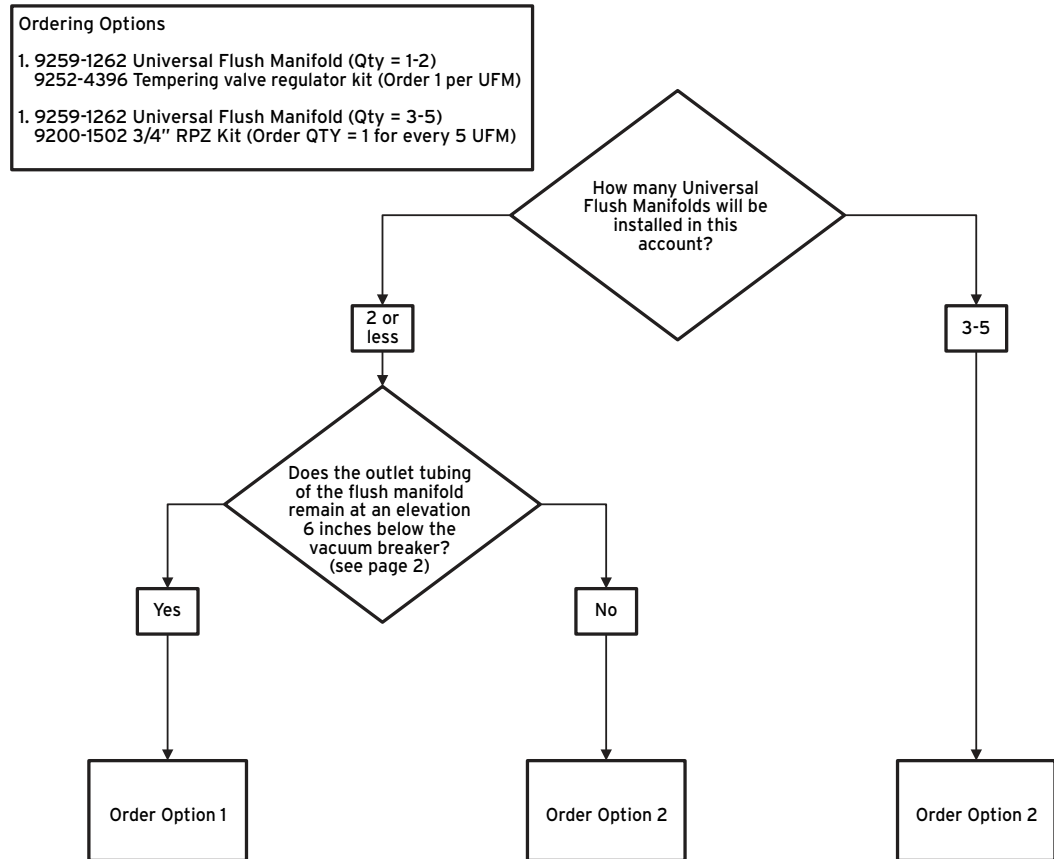

PART	PART NUMBER
------	-------------

1	MANIFOLD ASSEMBLY SEGMENT W/CHECK VALVE 3/8" TUBE ID	9259-0009
2	MANIFOLD ASSEMBLY SEGMENT W/CHECK VALVE 1/2" TUBE ID	9200-0413
3	FLOW SENSOR	8305-0153
4	SOLENOID VALVE	8526-0545
5	CHECK VALVE 3/8" TUBE ID	8524-4242
6	CHECK VALVE 1/2" TUBE ID	8524-4135
7	TEE, 1/4" PUSH-IN	8554-5044
8	TUBING, 3/8" (order by foot)	8501-5121
9	TUBING, 1/4" (order by foot)	8501-5170
10	1/2" hose barb (brass)	8578-3448
11	CHECK VALVE 3/8" ID TUBE FOR USE WITH DETERGENT PRODUCTS ONLY (L-2000, ECT.)	8524-4201
12	BUSHING 1/2X1/4 FOR USE WITH ITEM 11	8614-9259
	• AUDIBLE ALARM	8366-9004
	• FLOW SENSOR FITTINGS	8561-5482
	• CHECK VALVE INT.	8524-4473
	• PART NOT SHOWN	

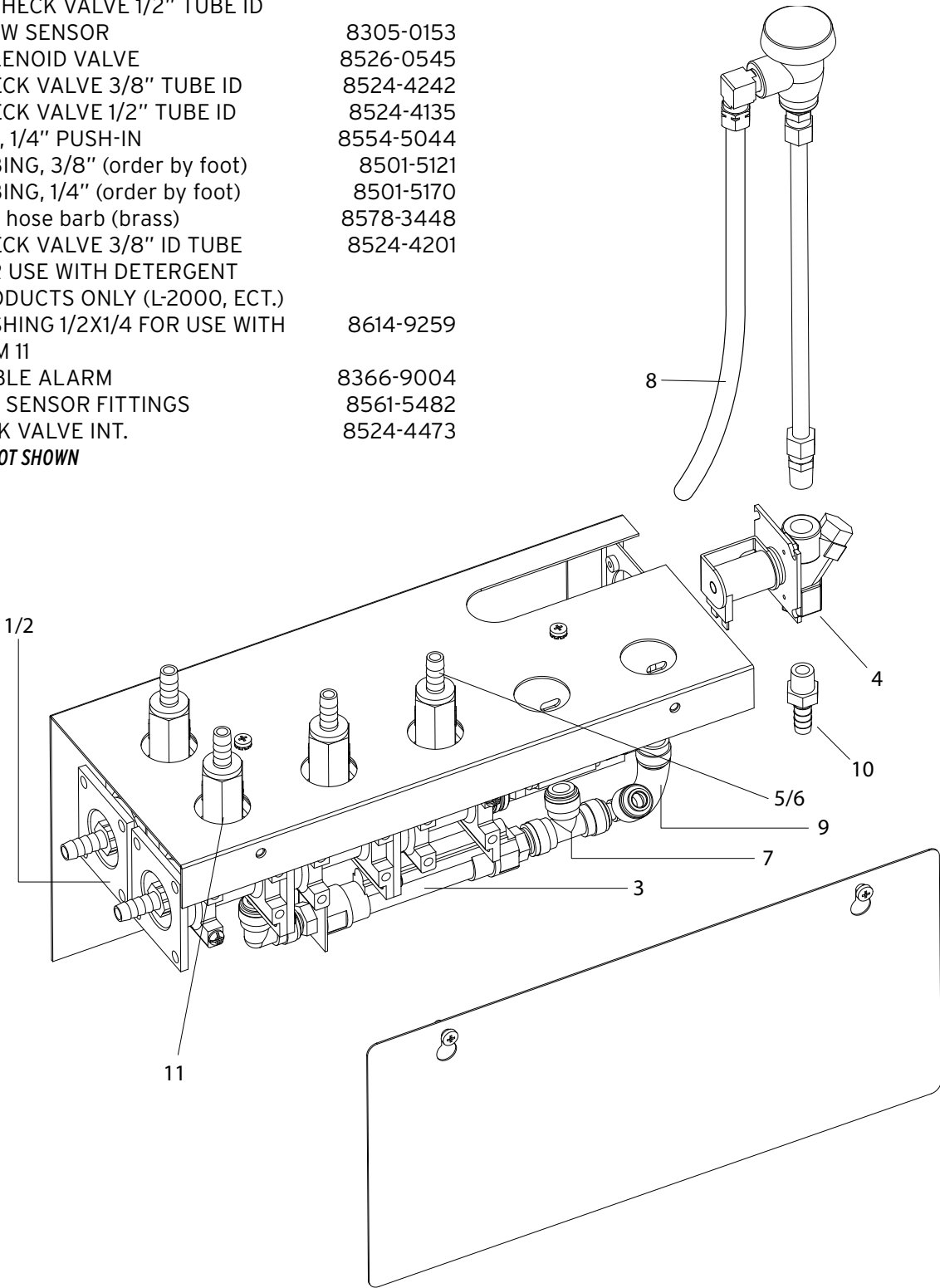

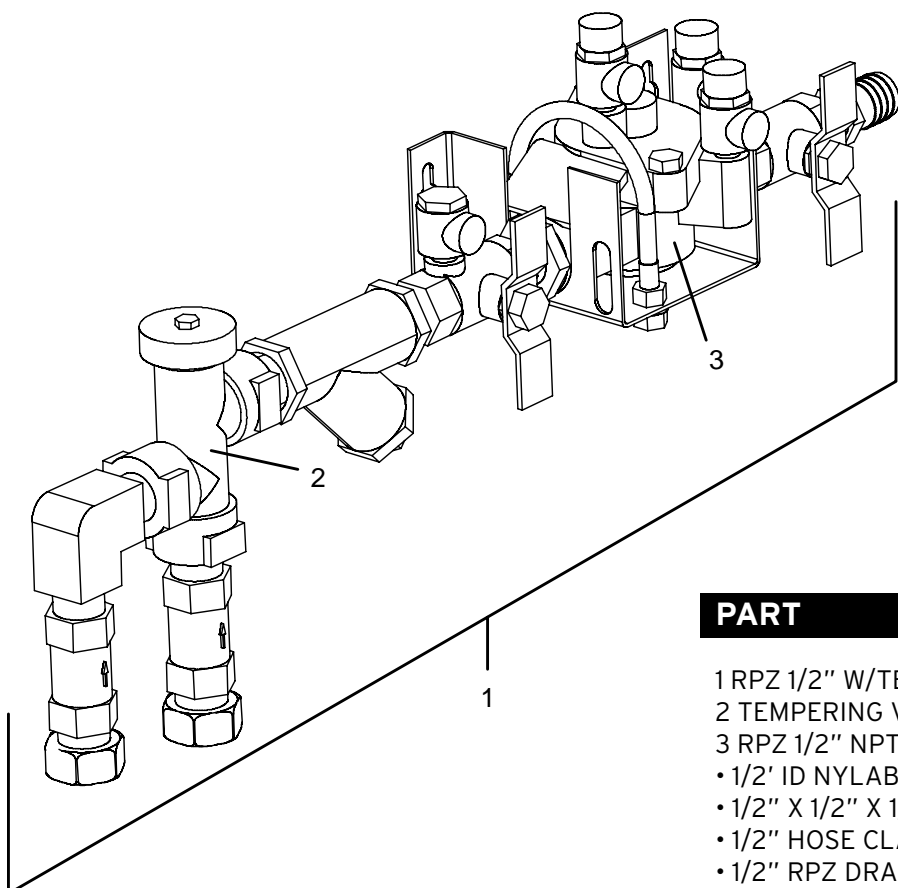
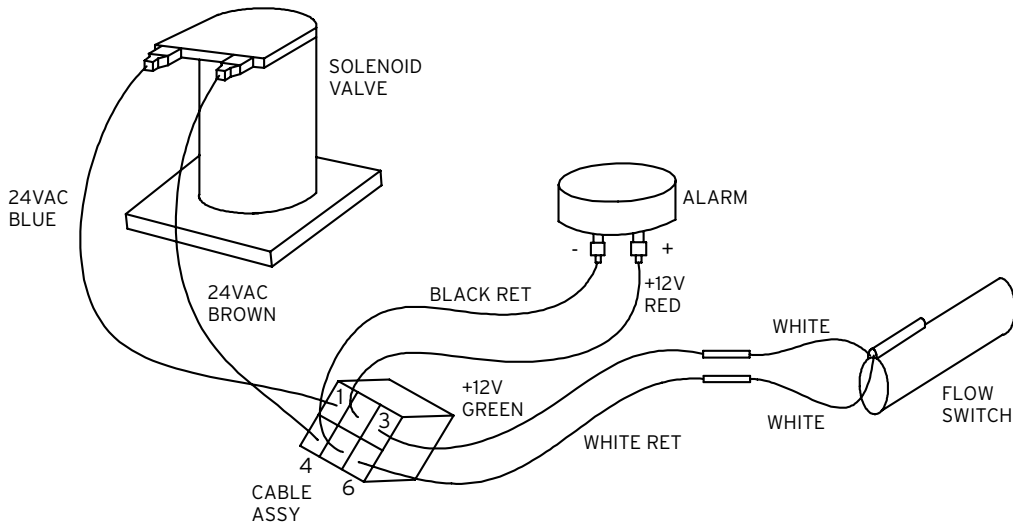

PART PART NUMBER

1 RPZ 1/2" W/TEMPERING VALVE KIT	9200-1502
2 TEMPERING VALVE	8529-0112
3 RPZ 1/2" NPT WITH STRAINER	9200-1019
• 1/2" ID NYLABRAID TUBING (300' COIL)	
• 1/2" X 1/2" X 1/2" BARBED TEE	8564-5067
• 1/2" HOSE CLAMP	8730-1032
• 1/2" RPZ DRAIN KIT	8528-0345
• 1/2" IN-LINE STRAINER KIT	9200-1020

APPLICATIONS OF 4 OR MORE WASHERS

• 3/4" X 1/2" ELBOW	9200-0371
• RPZ 3/4" W/TEMPERING VALVE KIT	9200-1098
• 3/4" HOSE CLAMP	8730-1131
• RPZ 3/4" NPT WITH STRAINER	9200-1022
• 3/4" IN-LINE STRAINER KIT	9200-1021

• PART NOT SHOWN